

# GV6-100 series

100W Waterproof Constant Voltage LED Driver



## Features:

- European AC input voltage: 176-264VAC
- Constant voltage design
- Built-in active PFC function (PF > 0.97)
- Protections: Short Circuit / Over Current / Over Temperature / Input Under Voltage
- Cooling by free air convection
- Surge immunity: Differential Mode - 6kV, Common Mode - 10kV
- IP67 design for indoor and outdoor applications
- Suitable for dry/damp/wet locations

## Application:

- Landscape Lighting



## DESCRIPTION

The GV6-100 series is constant voltage led driver, designed for lighting used for landscape illumination. The driver has built-in active PFC, multiple protections, and 10KV surge immunity. It's an excellent design with high reliability and long lifetime.

## MODEL INFORMATION

MODEL NUMBER	OUTPUT POWER [W]	OUTPUT VOLTAGE [VDC]	OUTPUT CURRENT RANGE [A]	TYPICAL EFFICIENCY	TYPICAL PF	TYPICAL THD
GV6-100B012	100	12	0 ÷ 8.3	87%	0.97	10%
GV6-100B024	100	24	0 ÷ 4.2	89%	0.97	10%
GV6-100B036	100	36	0 ÷ 2.8	89%	0.97	10%

### Notes:

1. All performance parameters are measured at 25°C ambient temperature, 230VAC input, full load conditions if no specific note.

## INPUT SPECIFICATIONS

Parameter	Min.	Typ.	Max.	Notes
INPUT VOLTAGE	176VAC	200 ÷ 240VAC	264VAC	-
INPUT FREQUENCY	47Hz	50/60Hz	63Hz	-
LEAKAGE CURRENT	-	-	0.7mA	240VAC/60Hz
INPUT AC CURRENT	-	-	0.8A	220-240VAC, full load
INRUSH CURRENT	-	-	75A	230VAC, full load
POWER FACTOR	0.96	0.98	-	230VAC, 50-60Hz, full load
	0.95	0.96	-	230VAC, 50-60Hz, 75% load
	0.9	0.92	-	230VAC, 50-60Hz, 50% load
THD	-	-	10%	220-240VAC, 50-60Hz, 50-100% load

# GV6-100 series

100W Waterproof Constant Voltage LED Driver



## OUTPUT SPECIFICATIONS

Parameter	Min.	Typ.	Max.	Notes
OUTPUT CURRENT TOLERANCE	-5%	-	+5%	-
TOTAL OUTPUT CURRENT RIPPLE (PK-PK)	-2%	-	2%	Full load, measured by 20MHz bandwidth oscilloscope and the output paralleled a 0.1μF ceramic capacitor and 47μF electrolytic capacitor
TURN-ON VOLTAGE OVERSHOOT	-5%	-	5%	220-240VAC, full load
LINE REGULATION	-0.5%	-	0.5%	25°C ± 10°C ambient temperature, input voltage changes from 176VAC to 264VAC
LOAD REGULATION	-1%	-	1%	25°C ± 10°C ambient temperature, 230 VAC input, load changes from 0% to 100%
TURN-ON DELAY TIME	-	0.5s	1s	230VAC, full load

## GENERAL SPECIFICATIONS

Parameter	Min.	Typ.	Max.	Notes
EFFICIENCY AT 230VAC				
GV6-100B024	87%	89%	-	25°C ambient temperature, full load
GV6-100B036	87%	89%	-	
DIELECTRIC STRENGTH	INPUT-OUTPUT	-	3750VAC	-
	INPUT-PE	-	1875VAC	-
	OUTPUT-PE	-	1600VAC	-
GROUNDING RESISTANCE	-	-	0.1Ω	25A/60s, 25°C ± 10°C ambient temperature
INSULATION RESISTANCE	10MΩ	-	-	Input-Output, Input-PE, Output-PE, 500VDC/60s/25°C/70%RH
MTBF	-	200 000 hours	-	25°C ± 10°C ambient temperature, 230VAC, 80% load (MIL-HDBK-217F)
LIFETIME	-	50 000 hours	-	230VAC, 100% load, tc=75°C (refer to Lifetime Curve)
OPERATING CASE TEMPERATURE FOR SAFETY T <sub>C_S</sub>	-40°C	-	+90°C	-
OPERATING CASE TEMPERATURE FOR SAFETY T <sub>C_W</sub>	-40°C	-	+75°C	5 years warranty, humidity 10% to 100% RH
STORAGE TEMPERATURE	-40°C	-	+90°C	Humidity 10% to 100% RH
DIMENSIONS (L x W x H)	147.5 x 67.2 x 37mm			-
NET WEIGHT	650 ± 50g			-
PACKAGE (L x W x H)	7kg; 10pcs./box; 500 x 310 x 160 mm			-

# GV6-100 series

100W Waterproof Constant Voltage LED Driver



## SAFETY STANDARDS

SAFETY CATEGORY	COUNTRY / TERRITORY	STANDARDS
CE	Europe	EN61347-1
		EN61347-2-13

## EMC STANDARDS

EMC CATEGORY	COUNTRY / TERRITORY	STANDARDS
CE	Europe	EN55015
		EN61000-3-2
		EN61000-3-3
		EN61547

**Note:** This LED driver meets the EMC specifications above, but EMC performance of luminaire that contains it depends also on the other devices connected to the driver and on the fixture itself.

## PROTECTIONS

PARAMETER	Min.	Typ.	Max.	NOTES
INPUT UNDER VOLTAGE PROTECTION	156Vac	-	176Vac	Turn off the output when the input voltage falls below protection voltage. Auto-recovery.
OVER TEMPERATURE PROTECTION	Turn off the output. Returning to normal after over temperature is removed.			
SHORT CIRCUIT PROTECTION	Hiccup mode. The output shall return to normal when the fault condition is removed.			
OVER CURRENT PROTECTION	Hiccup mode. The output shall return to normal when the fault condition is removed.			

# GV6-100 series

100W Waterproof Constant Voltage LED Driver

## MECHANICAL SPECIFICATION

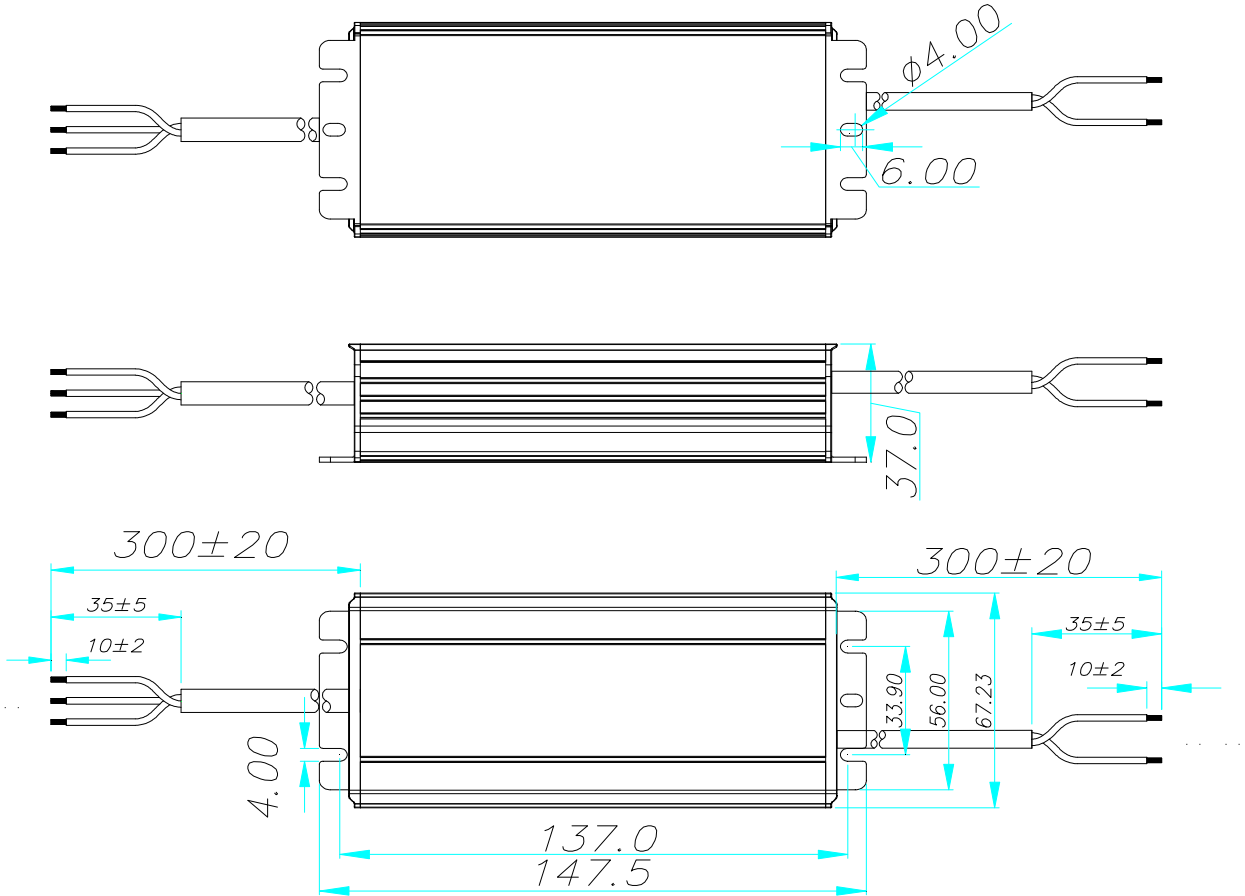

Wire	Specification	Note
INPUT	CCC + VDE, 3x1.0mm <sup>2</sup> , length = 300 ± 20mm, peel-length = 35 ± 5mm, Tin-Dip length = 10 ± 2mm	For CCC/CE
	AC/L: brown, AC/N: blue, FG: green/yellow	
OUTPUT	CCC + VDE, 2x1.0mm <sup>2</sup> , length = 300 ± 20mm, peel-length = 35 ± 5mm, Tin-Dip length = 10 ± 2mm	For CCC/CE
	V <sub>0+</sub> : brown, V <sub>0-</sub> : blue	

## CHARACTERISTICS

### INRUSH CURRENT WAVEFORM

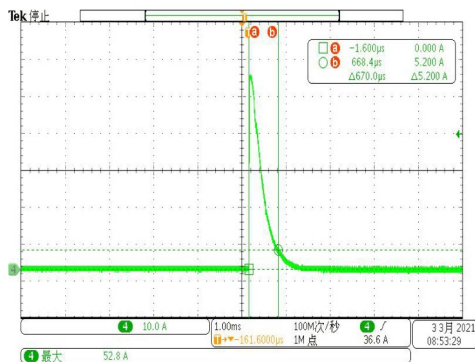

### DERATING CURVE

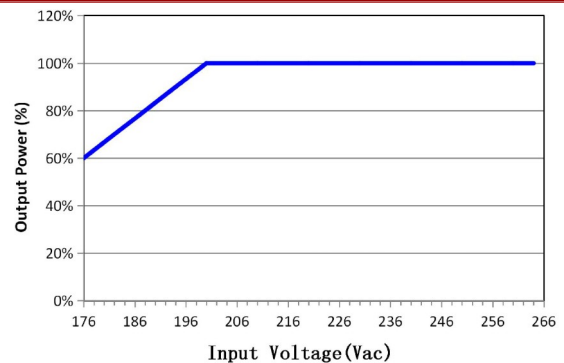

# GV6-100 series

100W Waterproof Constant Voltage LED Driver



## LIFETIME vs. CASE TEMPERATURE CURVE

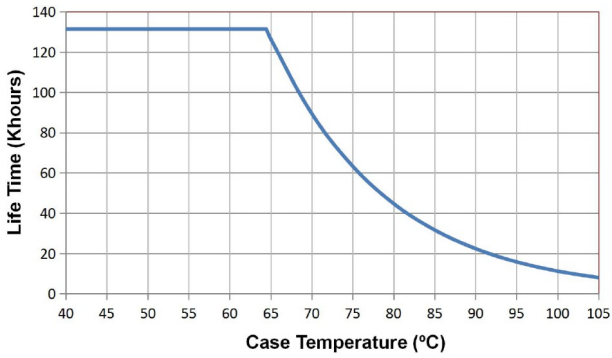

## POWER FACTOR vs. LOAD CURVE

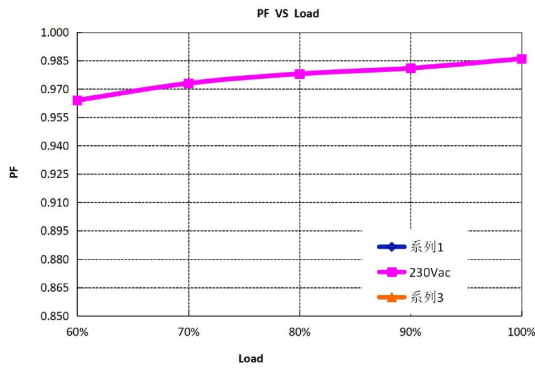

## THD vs. LOAD CURVE

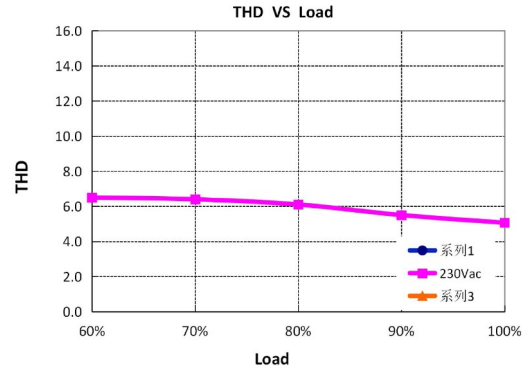

## EFFICIENCY vs. LOAD CURVE

### GV6-100B024

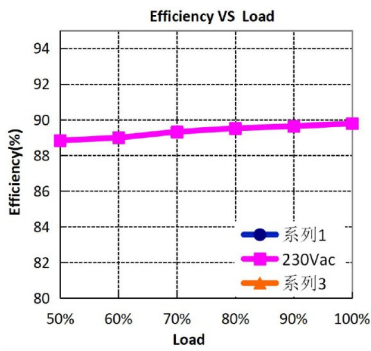

### GV6-100B036

